

sapa:

Architectural **Aluminium** Solutions



Confort 26

Sliding Systems

Sapa Building System



Confort 26 is a thermally insulated sliding system for windows and doors. The system is available in a 2- and 3- rail version, so a 6-leaf sliding door is perfectly feasible. The combination of a very appealing profile design, end caps and a wide range of design handles offer a nice solution for every building style.



System features

- » Confort 26 offers a wide range of frame profiles to allow a variety of building connections and design requirements. Solutions for hidden drainage are available.
- » Reinforced profiles make it possible to construct sliding doors up to 2,25 m.
- » The rail is available in stainless steel or anodised aluminium.
- » Stainless steel bottom rollers can take up to 200 kg for each vent and still ensure smooth operation. Synthetic rollers are also available.
- » Glass of 14 to 26 mm thick is pocket glazed.
- » Confort 26 is compatible with other Sapa Building System products such as fixed and turning systems, curtain walls, conservatories and fly screens.
- » A combination of multipoint locking and filling plugs with security features assures higher safety.

Resistance

- » The thermal insulation is assured by omega shaped, glass fibre reinforced polyamide strips.
- » A synthetic protection gutter between both rails offers increased thermal protection, whilst sealing the gap against dirt. Heat transmission is reduced and condensation is avoided.
- » Perfect drainage via punched drain holes, pre-punched glazing gaskets and sealing plugs.
- » Fin seal brush gaskets prevent water infiltration.
- » Brush filling plugs, positioned centrally between each vent, keep the sliding system draught free.
- » Weather resistance: A3, EE, V2 (NF P 20 501 / NF P 20 302)

Environment

- » All Sapa profiles are easily cleaned
- » Aluminium does not rust, rot or tear and the shape will not deform
- » Aluminium is a "green" product: it can be recycled infinitely without quality loss

Design

- » Confort 26 was particularly designed to offer a very appealing design in both frame and vent. The reinforced profiles have been developed in this philosophy as well.
- » The gutter detail allows the internal floor finish to be flush with the inner frame and avoids thresholds.
- » Handles can be used at in- and/or outside, they can be built in or on the profile, be automatic or not, and are available with or without key. The wide range of designs gives an answer to every personal request.
- » All standard shades and ventilation systems can easily be integrated.
- » A comprehensive range of supplementary finishing profiles allows the fenestration to be perfectly integrated into the building.
- » The end caps and filling plugs finish off Confort 26.

Finishes

- » Over 400 powder coated paint colours in matt, gloss or satin.
- » Unique wood effect, textured and textured metallic ranges are available.
- » Anodised finish is also an option.
- » Accessories can be supplied in corresponding colours to match the profiles.
- » The polyamide thermal break allows bi-colour finishes. As a result, the exterior building requirements do not infringe the interior design requests.
- » Our surface finishes meet the highest standards of Qualicoat or Qualanod.





Fabrication

- » Frames are assembled using eccentric or press corners. Vents are screwed together.
- All profiles are prefabricated using specially designed punching tools. The drainage holes, vent cut outs and the holes punched for the eccentric cleats are therefore very precise, making the composition very accurate and easy to assemble.
- Fabrication manuals and precise software enable the fabricator to proceed swiftly.
- Sapa Building System offers its software SapaLogic, an open concept for automation, to fabricators who have a CNC machining center.

Project support & service

- » Sapa Building System's experienced Project Team will advise you on the best product solutions
- » We can help you with pricing, strength calculations, building connections, thermal simulations, etc..
- » Specific project solutions can be developed
- » Samples, catalogues, technical specifications and digital drawings are available



SapaLogic is a user-friendly calculation program for fast, efficient and complete calculation of windows, doors, structures, curtain walls and conservatories. SapaLogic is very much complete but modular still: the different versions can be adapted to your company's needs.

SapaThermic is detailed thermal simulation software for doors, windows, sliding systems and curtain walls. It can either be linked to SapaLogic or act as a stand-alone version.

Applications

2-rail

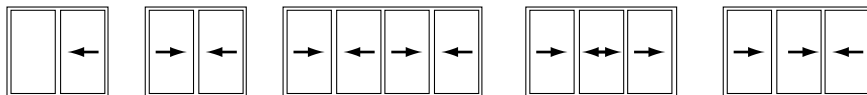

3-rail

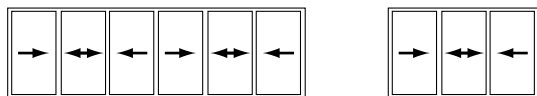

Dimensions

Min. sightline horizontal	93,5 mm
Min. sightline vertical	106 mm
Min. sightline transom in vent	50,5 mm
Min. Profile depth frame 2-rail	50 / 84 mm
Min. Profile depth frame 3-rail	96,5 / 130,5 mm
Min. Profile depth vent	36,5 mm
Max height	2250 mm

Glazing

Infill thickness	8 - 26 mm
Glazing method	pocket glazed
Gaskets	EPDM

Performances

Thermal break	14,8 mm polyamides PA 6.6 GF25	
Air permeability	A3	NF P 20 501 / NF P 20 302
Water tightness	EE	NF P 20 501 / NF P 20 302
Wind resistance, security test	V2	NF P 20 501 / NF P 20 302
Acoustic insulation	$R_w (C;C_{tr}) = 31 (0;-2) \text{ dB (5/12/44.2)}$	EN ISO 717 / EN ISO 140

* This information is only an indication. For more information, please consult your local Sapa Building System branch.

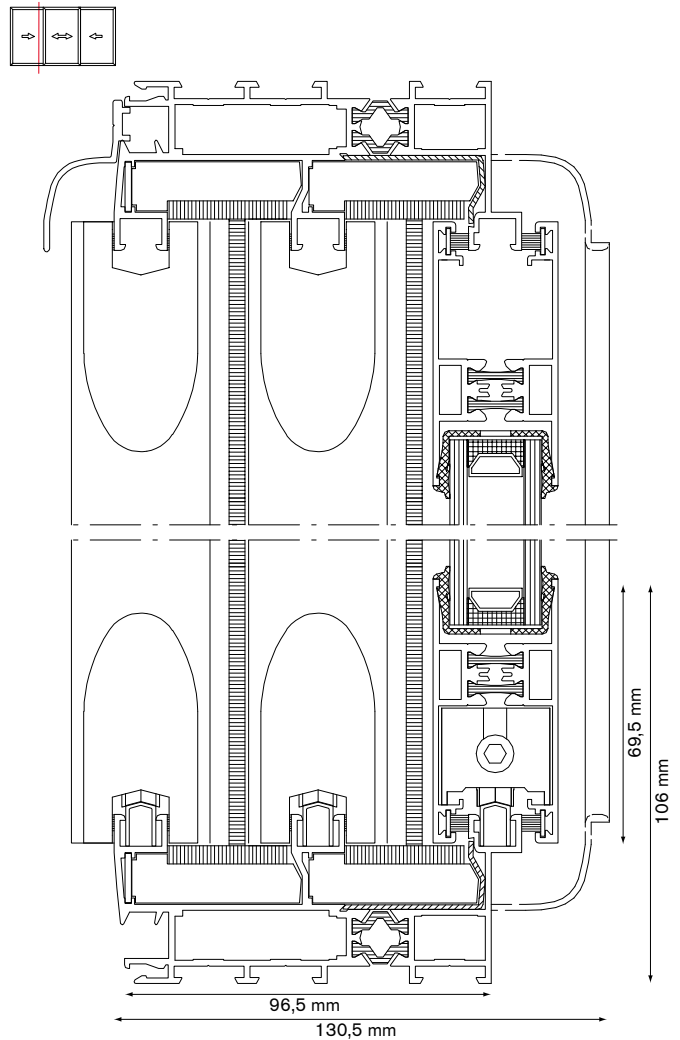
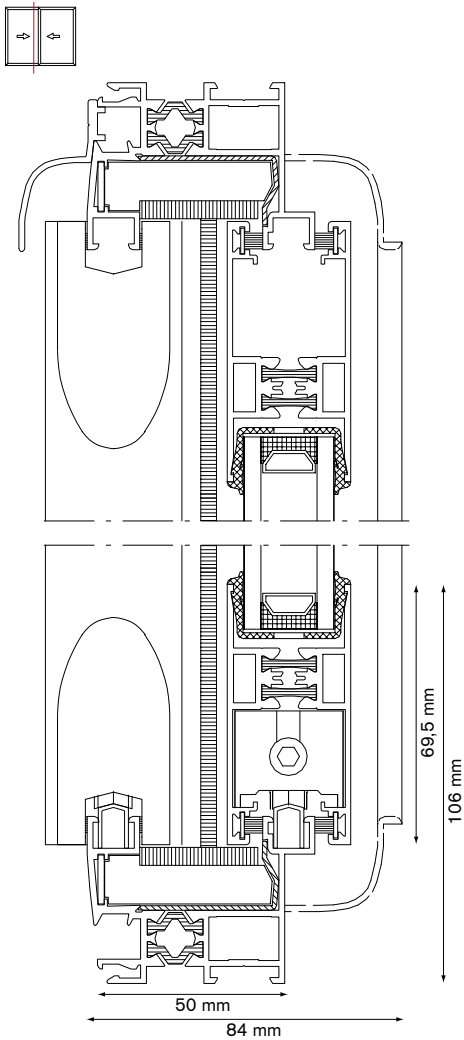
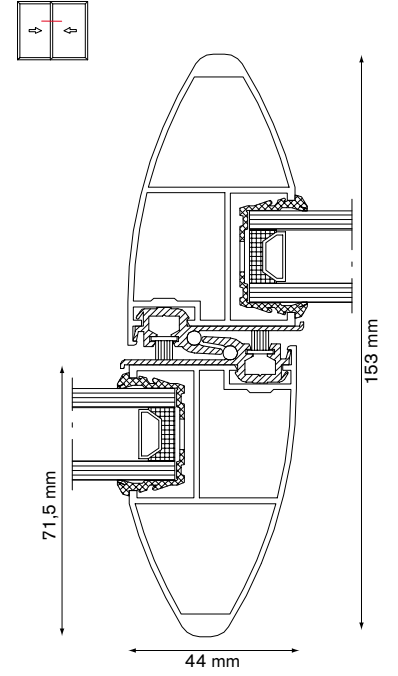
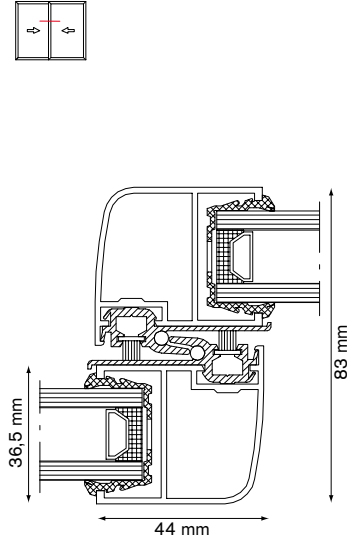
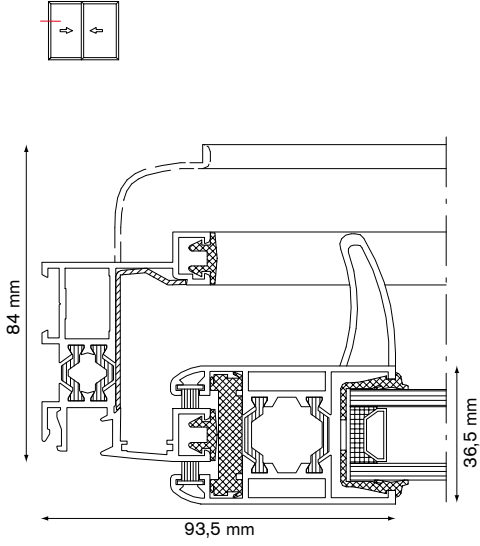

Sapa Building System, is one of the largest suppliers of aluminium building systems in Europe and is part of the Swedish group Sapa. The core business is the development and distribution of aluminium profile systems. Sapa Building System aims for well-developed systems and project solutions offering a tangible added value to fabricators, architects, investors and home-owners.

Windows and Doors

Sliding Systems

Curtain Walls

Conservatories

Balustrades, gates and others

BIPV

Your local Sapa Building System fabricator

Sapa Building System NV

Postal address **Industrielaan 17, BE-8810 Lichtervelde** Tel. **+32 51 72 96 66** Fax **+32 51 72 96 89**

Postal address **Industriezone Roosveld 11, BE-3400 Landen** Tel. **+32 11 69 03 11** Fax **+32 11 83 20 04**

E-mail **buildingsystem.be@sapagroup.com** Website **www.sapabuildingsystem.be**

